



VEROLIGHT

3-Phasen Stromschienen





[Bestellformular senden](#)



INHALTSVERZEICHNIS



ON-OFF

3-PHASEN-SCHIENENSYSTEM

EINSPEISUNGEN

VERBINDER

ADAPTER

DALI

3-PHASEN-SCHIENENSYSTEM
DALI

EINSPEISUNGEN

VERBINDER

ADAPTER



ON-OFF / DALI

FIX POINT

ZUBEHÖR

STRAHLER

AUFHÄNGUNGEN

NIPPEL

3-PHASEN SCHIENENSYSTEM

Farbvarianten

Bitte bei Bestellung angeben. Zum Beispiel XTS 4100- 3 = Weiss



STROMSCHIENE AUFBAU

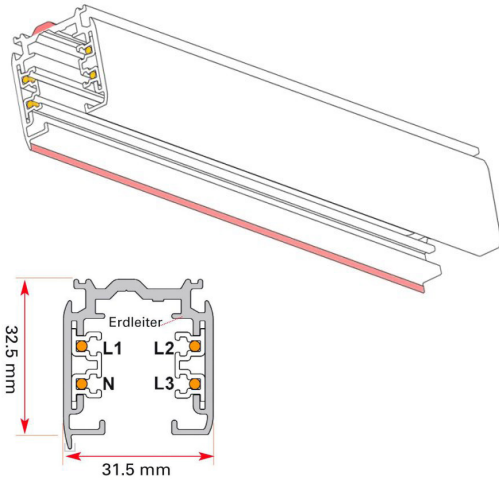

Art.-Nr.	Farbe	Länge	Anzahl
XTS 4100	1 2 3	1000mm	
XTS 4200	1 2 3	2000mm	
XTS 4300	1 2 3	3000mm	
XTS 4400	1 2 3	4000mm	

STROMSCHIENE EINBAU

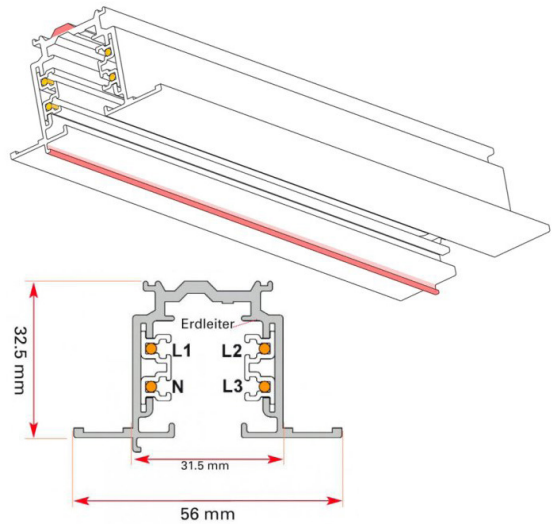

Art.-Nr.	Farbe	Länge	Anzahl
XTSF 4100	1 2 3	1000mm	
XTSF 4200	1 2 3	2000mm	
XTSF 4300	1 2 3	3000mm	

EINSPEISUNGEN

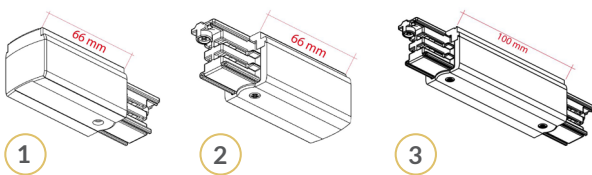

Art.-Nr.	Farbe	Beschreibung	Anzahl
1 XTS 11	1 2 3	Einspeisung Links	
2 XTS 12	1 2 3	Einspeisung Rechts	
3 XTS 14	1 2 3	Mitteinspeisung	

FIX POINT



Anschluss 250 V 10 A
Schutzklasse 1
Tragfähigkeit 50 N
Drehmoment max. 2,5 Nm

Einstellbar für verschiedene
Deckenstärken.
Tragfähigkeit 50 N

Art.-Nr.	Farbe	Beschreibung	Anzahl
4 GA 70	1 2 3	Decken und Wand- auslass	
5 XTSA 71	1 2 3	Einbaurahmen für Fixpoint XTSA 70	



VERBINDER

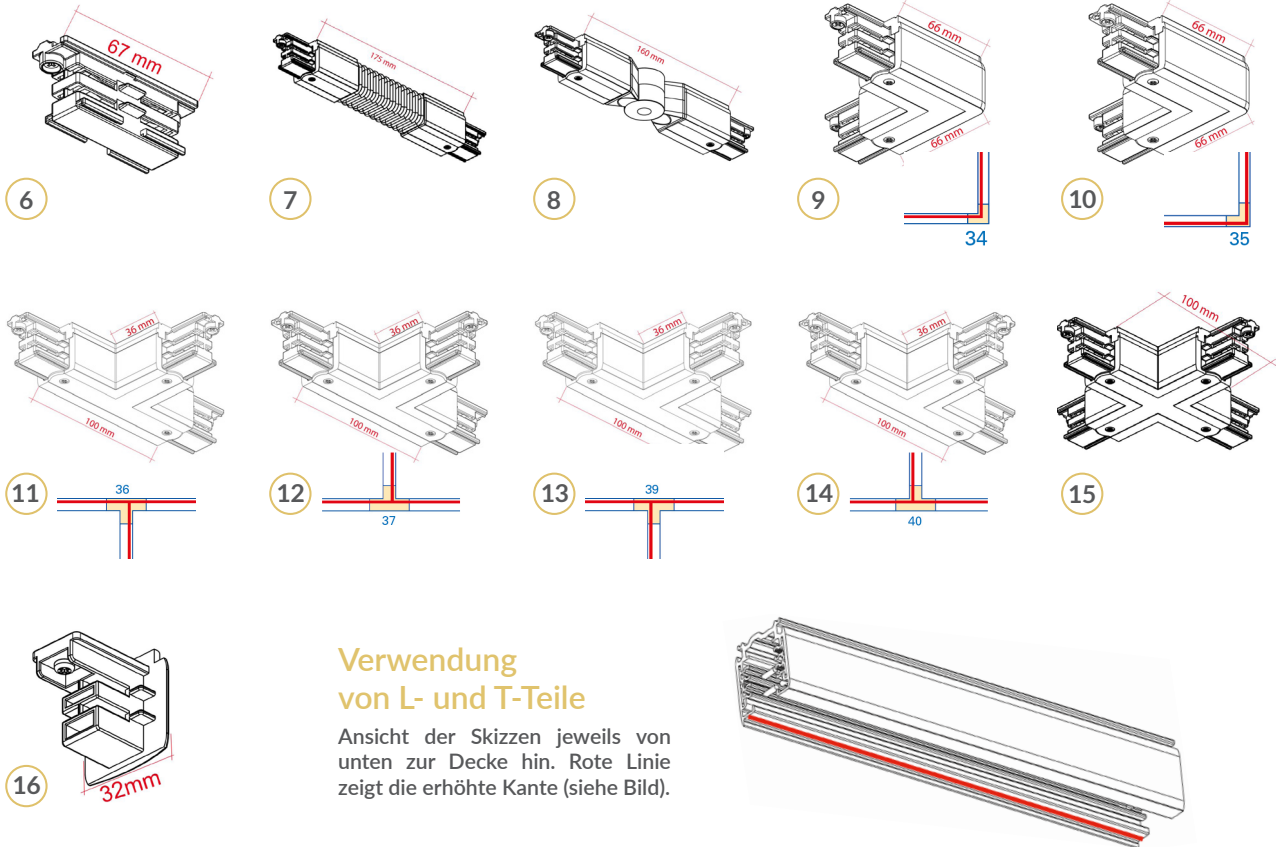

Verwendung von L- und T-Teile

Ansicht der Skizzen jeweils von unten zur Decke hin. Rote Linie zeigt die erhöhte Kante (siehe Bild).

Art.-Nr.	Farbe	Beschreibung	Anzahl
6	XTS 21	1 2 3 Innenverbinder	
7	XTS 23	1 2 3 Flexibler Verbinder	
8	XTS 24	1 2 3 Einstellbarer Verbinder	
9	XTS 34	1 2 3 L - Verbinder	
10	XTS 35	1 2 3 L - Verbinder	

Art.-Nr.	Farbe	Beschreibung	Anzahl
11	XTS 36	1 2 3 T-Verbinder	
12	XTS 37	1 2 3 T-Verbinder	
13	XTS 39	1 2 3 T-Verbinder	
14	XTS 40	1 2 3 T-Verbinder	
15	XTS 38	1 2 3 Kreuz-Verbinder	
16	XTS 41	1 2 3 Endkappe	

3-PHASEN
SCHIENENSYSTEM

AUFHÄNGUNGEN



17

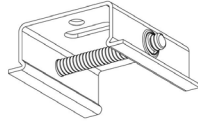

18

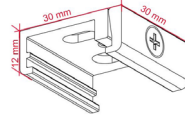

19

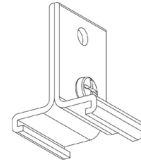

20

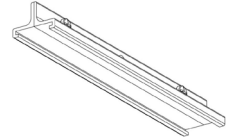

21

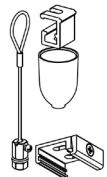

22

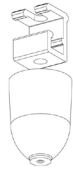

23



24

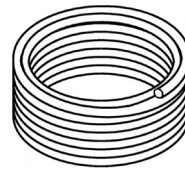

25



26



27



28

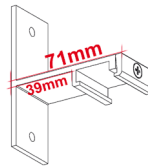

29

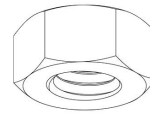

30

Art.-Nr.	Farbe	Beschreibung	Anzahl
17	1 2 3	Seilset 3m	
18	1 X 3	Deckenhalterung	
19	1 2 3	Deckenhalterung für abgehängte Decken-Trägerprofile	
20	1 2 3	Abhängeklammer	
21	1 2 3	Abhängebrücke	
22	1 2 3	Seilaufhängung Set 1.5 m, 3 m, 5 m	
23	1 2 3	Baldachin und Deckenhalterung	

Art.-Nr.	Beschreibung	Anzahl
24	XSKB 31 Gewindestange M6	
25	XSKB 32 Abdeckungsschlauch 25 Meter	
26	XSKB 40 Verstellbarer Gewindenippel	
27	XTAK 14 Befestigung für Dekohaken	
28	XTAK 11 Dekohaken	
29	XSKB 21 Wandhalterung	
30	XSKB 6 Mutter M6	

X = Die entsprechende Farbvariante ist nicht verfügbar



3-PHASEN SCHIENENSYSTEM

ZUBEHÖR

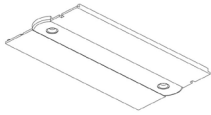

31

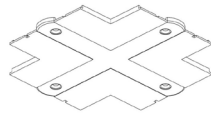

32

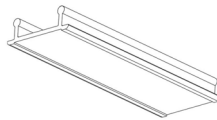

33

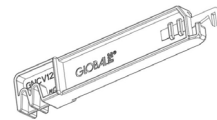

34

Art.-Nr.	Farbe	Beschreibung	Anzahl
31 XTSF 10	1 2 3	Abdeckplatte für Einspeisung	
32 XTSF 30	1 2 3	Abdeckplatte für Kreuzverbindung	

Art.-Nr.	Farbe	Beschreibung	Anzahl
33 XTSP 11	X 2 3	Abdeckung L = 3m	
34 XTSV 12	Blau	Leiterbiegeschlüssel	

ADAPTER

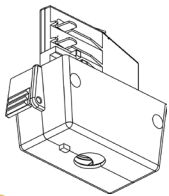

31

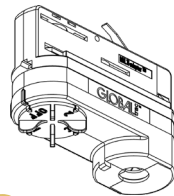

32

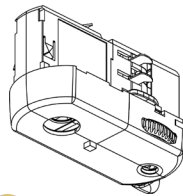

33

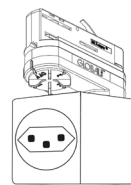

34

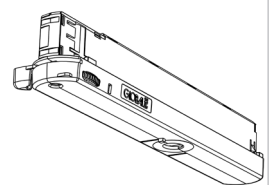

35

Art.-Nr.	Farbe	Beschreibung	Anzahl
31 XTSA 67	X 2 3	Zum Anschluss von Leuchten in 1- und 3-Phasen Stromschiene, weiss, schwarz	
32 XTSA 68	1 2 3	Multi Adapter 10 A zum Anschluss von Leuchten in 3-Phasen Stromschiene	

Art.-Nr.	Farbe	Beschreibung	Anzahl
33 GA 69	1 2 3	Multi Adapter 6 A zum Anschluss von Leuchten in 3-Phasen Stromschiene	
34 XTSA 68/SD/T23	X 2 3	Steckdosen Adapter, in weiss, schwarz	
35 GA16	1 2 3	Adapter	

- 3 Phasen Stromschiene-Adapter GA 69 und XTSA68 passen auf nachfolgende Schienen-Hersteller(Euro-Kompatibel):
 - Nordic Aluminium · Eutrac · Ivela · Erco · Zumtobel · iGuzzini
- Alle anderen Adapter wie GB67, GA016, GAC600 Dali passen nur auf Nordic Aluminium.
- Punktauslass GA70 ist nicht Euro-Kompatibel und passt nur mit GA69 NordicAluminium.

X = Die entsprechende Farbvariante ist nicht verfügbar



3-PHASEN SCHIENENSYSTEM

NIPPEL

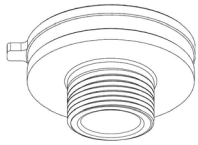

36

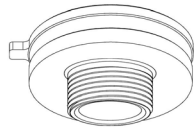

37

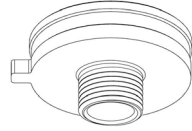

38

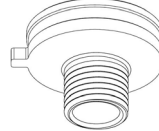

39

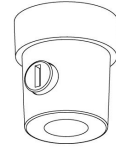

40

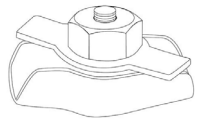

41

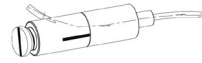

42

Art.-Nr.	Beschreibung	Anzahl
36	Rotierende Nippel M 13, L 12	
37	Feste Nippel M 13, L 8	
38	Rotierende Nippel M 10, L 8	
39	Rotierende Nippel M 10, L 12	

Art.-Nr.	Farbe	Beschreibung	Anzahl
40	1 2 3	Zugentlaster Kunststoff	
41		Seilklemme aus Stahl	
42		Justierelement aus Stahl	



3-PHASEN SCHIENENSYSTEM DALI

STROMSCHIENE AUFBAU

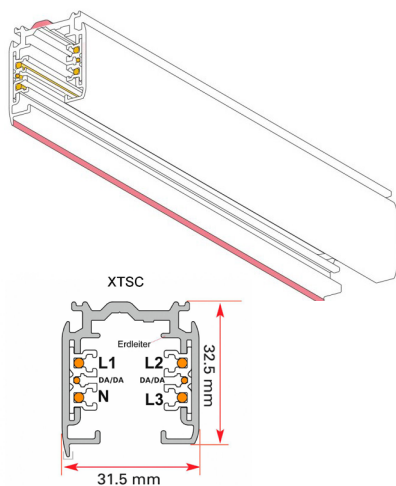

Art.-Nr.	Farbe	Länge	Anzahl
XTSC 6100	1 2 3	1000mm	
XTSC 6200	1 2 3	2000mm	
XTSC 6300	1 2 3	3000mm	
XTSC 6400	1 2 3	4000mm	

STROMSCHIENE EINBAU

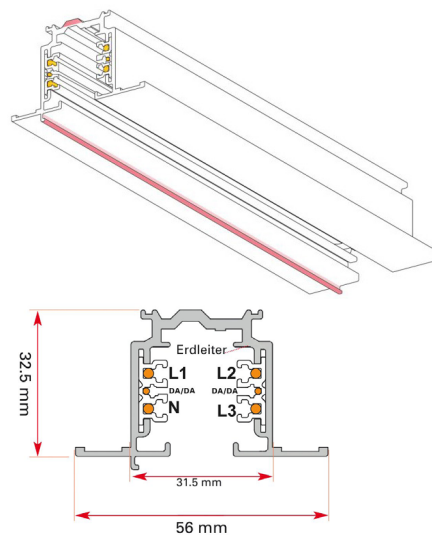

Art.-Nr.	Farbe	Länge	Anzahl
XTSCF 6100	1 2 3	1000mm	
XTSCF 6200	1 2 3	2000mm	
XTSCF 6300	1 2 3	3000mm	

EINSPEISUNGEN

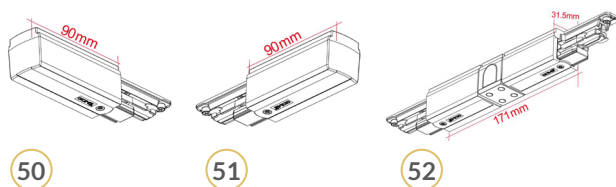

Art.-Nr.	Farbe	Beschreibung	Anzahl
50 XTSC 611	1 2 3	Einspeisung Links	
51 XTSC 612	1 2 3	Einspeisung Rechts	
52 XTSC 614	1 2 3	Mittleinspeisung	

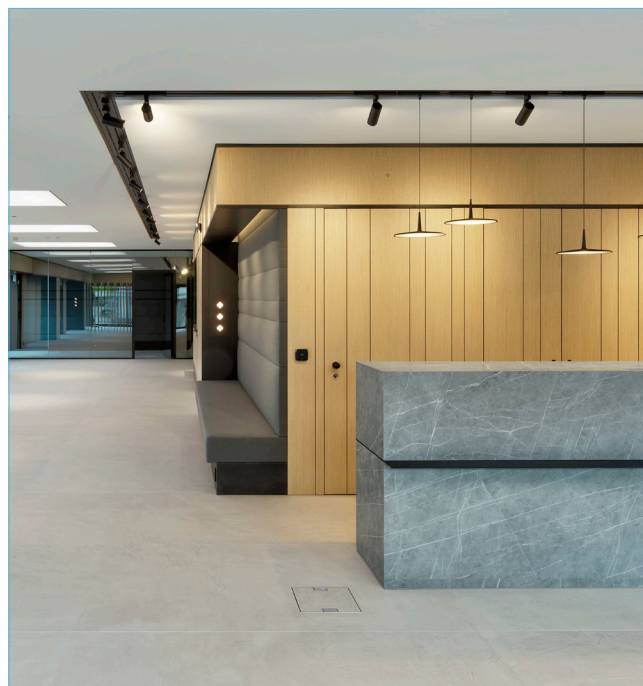

VERBINDER

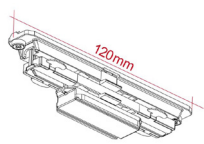

53

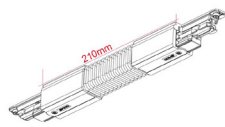

54

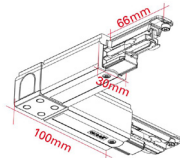

55

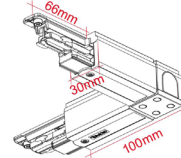

56

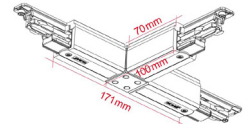

57

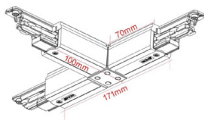

58

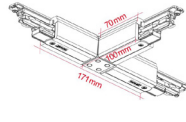

59

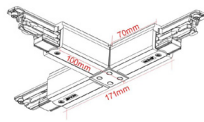

60

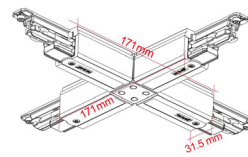

61

Art.-Nr.	Farbe	Beschreibung	Anzahl
53	1 2 3	Innenverbinder	
54	1 2 3	Flexibler Verbinder	
55	1 2 3	L-Verbinder	
56	1 2 3	L-Verbinder	
57	1 2 3	T-Verbinder	

Art.-Nr.	Farbe	Beschreibung	Anzahl
58	1 2 3	T-Verbinder	
59	1 2 3	T-Verbinder	
60	1 2 3	T-Verbinder	
61	1 2 3	Kreuzverbinder	

ADAPTER

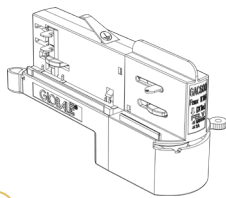

62

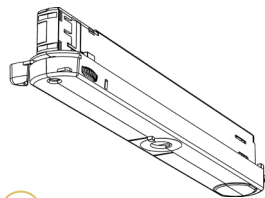

63

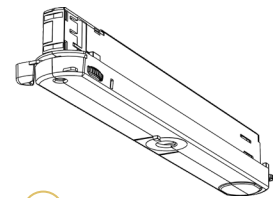

64

Art.-Nr.	Farbe	Beschreibung	Anzahl
62	1 2 3	7-L, 3-Phasen-Selektionsadapter, dimmbar	
63	1 2 3	DALI 7-L, 3-Phasen- Selektionsadapter, 300-1050mA mit integriertem Trafo, max 31W/0.70A, max 31W / 0.70A	
64	1 2 3	CASAMBI 7-L, 3-Phasen- Selektionsadapter, 325-700mA mit integriertem Trafo, max 31W/0.70A	



STRAHLER



I-ZOOM MINI



AKRA STRAHLER



VERO TRACKLIGHT TL44



VERO TRACKLIGHT TL45



VERO TRACKLIGHT TL46



VERO TRACKLIGHT TL53



VERO TRACKLIGHT TL54



OVEGA PREMIUM



OVEGA ZOOM



OVEGA PREMIUM SMALL



I-MAX FOCUS



ORIONIS ZOOM



Verolight AG
Kreuzmatte 1
CH-6260 Mehliseecken

+41 (0) 62 552 22 00
vertrieb@verolight.com
www.verolight.com

verolight[®]



Bestellformular senden